

ECC 85
V880

Spannungen gemessen mit rVM
Werte ohne Klammern in Schalterstellung UKW
Werte eingeklammert in Schalterstellung UKW
Voltages measured with rVM
Values without brackets for position UKW
Values in brackets for position UKW

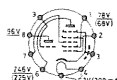

ECH 81
V881

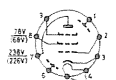

EF 89
V882

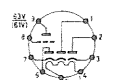

EABC80
V883

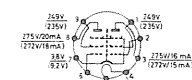

ELL 80
V884

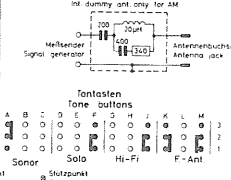
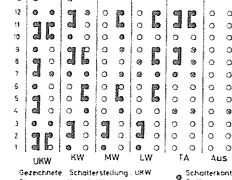
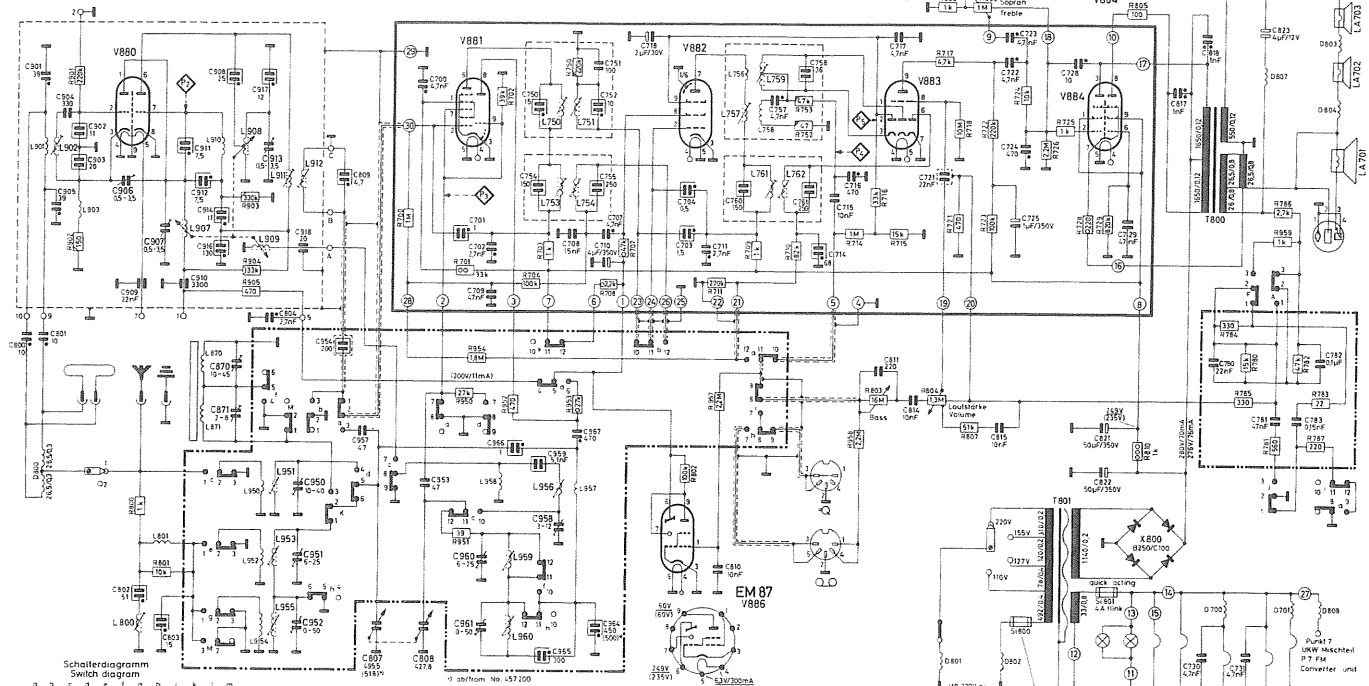

Bereich	Schwingenspannung	Geneser mit
Band	Diac voltage	Roehren-voltmeter an
KW	4 - 8 V	P 3
MW	3 - 11 V	P 3
LW	7 - 13 V	P 3
UKW	15 - 35 V	P 2

Die Schwingenspannungen sind stark von der Röhre ECH 81 (V881) abhängig.
The oscillator voltages depend very much on tube ECH 81 (V881).

ZF/IF AM 460 kHz/kc
ZF/IF FM 10,7 MHz/Mc

Betriebsspannung
Operating voltages

Belastbarkeit
Rating

110-220V
110V - 155V/USA-Präge
2100V/2A-Präge
110V - 155V/USA - slow blow
2100V/2A - slow blow

EM 87 V885
T801
X800
C801, C802, C803, C804, C805, C806, C807, C808, C809, C810, C811, C812, C813, C814, C815, C816, C817, C818, C819, C820, C821, C822, C823, C824, C825, C826, C827, C828, C829, C830, C831, C832, C833, C834, C835, C836, C837, C838, C839, C840, C841, C842, C843, C844, C845, C846, C847, C848, C849, C850, C851, C852, C853, C854, C855, C856, C857, C858, C859, C860, C861, C862, C863, C864, C865, C866, C867, C868, C869, C870, C871, C872, C873, C874, C875, C876, C877, C878, C879, C880, C881, C882, C883, C884, C885, C886, C887, C888, C889, C890, C891, C892, C893, C894, C895, C896, C897, C898, C899, C900, C901, C902, C903, C904, C905, C906, C907, C908, C909, C910, C911, C912, C913, C914, C915, C916, C917, C918, C919, C920, C921, C922, C923, C924, C925, C926, C927, C928, C929, C930, C931, C932, C933, C934, C935, C936, C937, C938, C939, C940, C941, C942, C943, C944, C945, C946, C947, C948, C949, C950, C951, C952, C953, C954, C955, C956, C957, C958, C959, C960, C961, C962, C963, C964, C965, C966, C967, C968, C969, C970, C971, C972, C973, C974, C975, C976, C977, C978, C979, C980, C981, C982, C983, C984, C985, C986, C987, C988, C989, C990, C991, C992, C993, C994, C995, C996, C997, C998, C999, C1000

BLAUPUNKT
Granada
22300

Änderungen vorbehalten! Modifications reserved!